

Heavy-Duty Locking Connectors (HDLC)

- IP67 Rated
- VG 95 234 NATO Specification
- Contact Type: Hard Silver Crimp
- Number of Circuits: 1 to 65
- DIN 40 050 Rated
- Vibration: 200 m/s² at 10 to 2,000 Hz. To VG 95 234 Test 5.16
- Shock: 50g 11ms, Three Major Axes. To VG 95 234 Test 5.17
- Operating Temperature Range -55°C to 125°C
- Mating Life: 2,000 Cycles Minimum (Commercial)
500 Cycles Minimum (to VG 95 234)

The most advanced line of connectors available according to MIL-C-5015 and VG95234. The HDLC connector series were developed specifically to meet the demands of industrial environments. The HDLC series shares the same shell dimensions, contact layouts, and electrical performance characteristics as the common MIL-C-5015 connectors with application engineered features such as three-quarter reverse bayonet coupling system, rubber covered coupling ring, black zinc shell plating and a superior sealing and strain relief system. Available in sizes from #18 to #1/0.

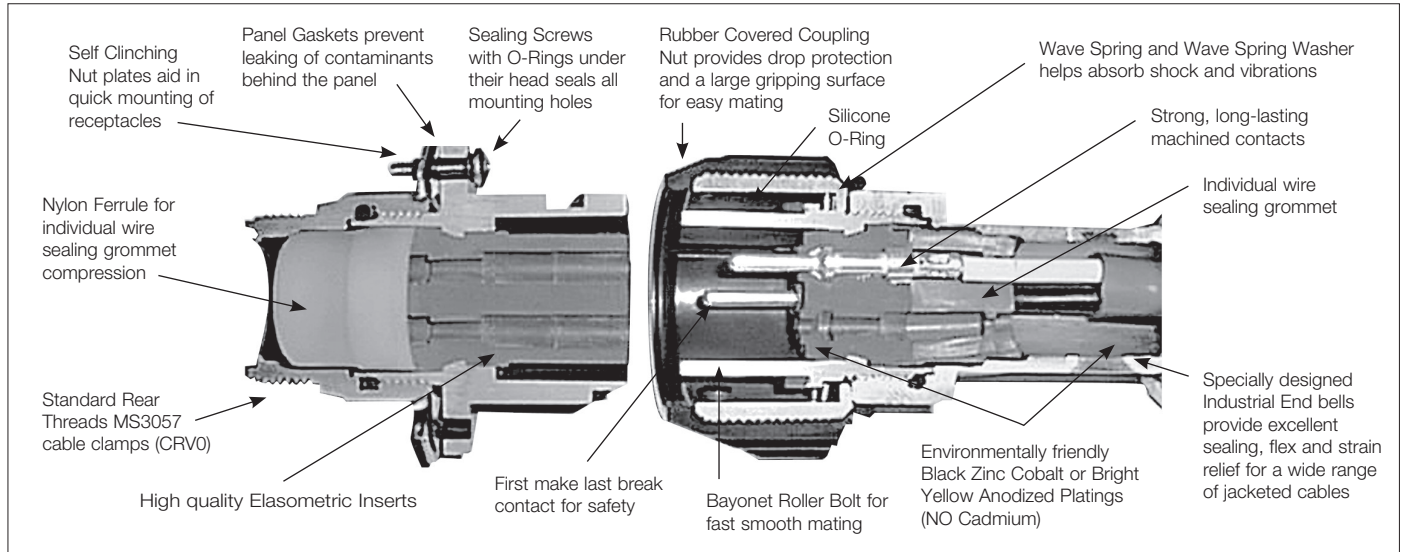

FEATURES & BENEFITS

1. THREE QUARTER TURN REVERSE BAYONET COUPLING SYSTEM

— Easy to connect and disconnect, positive locking indent prevents accidental uncoupling.

2. RUBBER COVERED COUPLING RING — Protects the nut against damage from impact, provides a large non-slip gripping surface for easy mating.

3. ENVIRONMENTALLY SEALED — The inserts of the HDLC are environmentally sealed to protect the connection against oil, water and chemical contamination. The end bells are sealed with a tapered grommet sized to the specific cable providing a waterproof seal.

4. MACHINED CONTACTS — All contacts are machined, not stamped. This produces a heavier industrial contact that is less likely to crack or break during the crimp process.

HDLC Series connectors are the ideal “bulletproof” choice for your applications:

- Superior three-quarter turn reverse bayonet coupling system.
- Rubber covered coupling ring for superior grip and damage prevention.
- Superior sealing and strain relief system.
- First-mate, last-break screw machined crimp contacts for reliability and safety.
- Over 91 contact layouts available with wire sizes from 16 AWG to 0 AWG.
- Superior shock and vibration resistant design.
- Environmentally friendly black zinc shell plating (no cadmium).

5. MESH STRAIN RELIEF — Each assembly end comes with a double weave strain relief for pull-out protection as well as flex relief for the cable.

6. FIRST MATE — LAST BREAK CONTACT — An extended ground pin insures first mate/last break contact for safety.

7. SUPERIOR SHOCK AND VIBRATION RESISTANCE — Each connector contains a wave spring and wave spring washer designed to absorb shock and vibration in the coupler before it reaches the contacts. This helps to eliminate pin elongation and damage that may cause arcing and connector failure.

8. AVAILABLE IN AWG SIZES RANGING FROM #18 TO #1/0 — The HDLC connector accepts a wide range of Gauge sizes and configurations to meet your connector needs.



Heavy-Duty Locking Connectors (HDLC) (Continued)

TECHNICAL SPECIFICATIONS

MATERIALS & FINISHES

Shell	Aluminum alloy (shells can be grounded)
Plating	Black zinc cobalt, bright yellow anodized
Contacts	Copper alloy
Platings	Hard silver plating
Insulator	Resilient polychloroprene (Neoprene)
Seals	Neoprene

ELECTRICAL DATA

The indicated values for the "operating voltage" are limits concerning the electrical function. In any case, when the working voltage exceeds 50 V, safety precautions must be in accordance with the following standards: **VDE 0100, IEC 309-1 or applicable national standards.**

Operating Voltage/Test Voltage According to MIL-C-5015

SERVICE RATING	OPERATING VOLUME		TEST VOLTAGE AC VRMS
	DC V	AC VRMS	
I	250	200	1,000
A	700	500	2,000
D	1,250	900	2,800
E	1,750	1,250	3,500
B	2,450	1,750	4,500

Current Rating at 68° F (+20°C)

CONTACT SIZE	MAX. CURRENT (AMPS)
16/16S	22
12	41
8	74
4	135
0	245

Current Rating (by ambient temperature)

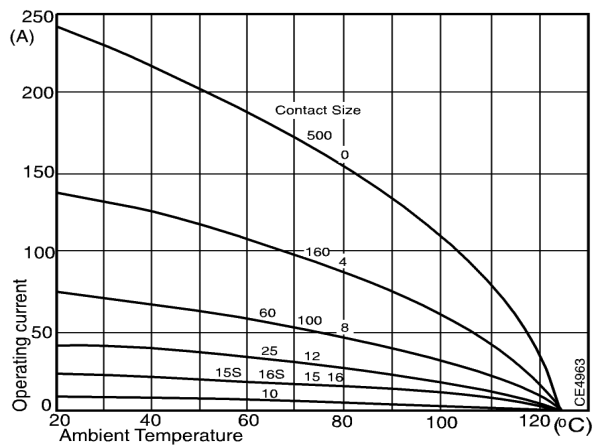

Wire Range Sizes

26 AWG TO 0 AWG (See contact selection on page 302–305).

Contact Resistance

Tested according to VG95234 Test 5.10.

CONTACT SIZE	CONTACT RESISTANCE MILLIOHM MAX.
16/16S	6
12	3
8	1
4	0.5
0	0.2

Mini Quick-Connects™
 Micro Quick-Connects™
 Nano Quick-Connects™
 Specialty Quick-Connects™
 Ethernet Cable Assemblies
 7 Pin Molded Valve Plug
 DIN Connectors
 Extension Cords
 M23 Connector Assemblies
 Military Connectors
 Rectangular Connectors

Heavy-Duty Locking Connectors (HDLC) (Continued)

TECHNICAL SPECIFICATIONS (Continued)

MECHANICAL

Insulation Resistance >1000 Megohm According to VG 95 319 Test 5.12 and VG 95 210 Part 32, Test condition B.

Operating Temperature -55° to +125°C (-67° to +257°F).

Sealing Fully submersible to 1 bar (35 feet) when mated. Meets IP67, DIN 40 050, VG 95 234.

Wire Sealing Range The connector is designed for individual wire sealing. Sealing of an outer cable jacket on multi-conductor cables is accomplished with the sealed end bell. Sealing is only guaranteed if wires according to MIL-W-5086 or within the listed ranges are used.

CONTACT SIZE	WIRE SIZE (MIL-W-5086)	INSULATION O.D. LIMIT (in)			
		MIN. (mm)		MAX. (mm)	
16/16S	16	0.087"	(2.2)	0.110"	(2.8)
12	12	0.122"	(3.1)	0.138"	(3.5)
8	8	0.220"	(5.6)	0.256"	(6.5)
4	4	0.335"	(8.5)	0.370"	(9.4)
0	0	0.452"	(11.5)	0.512"	(13.0)

Mating Life 2,000 cycles minimum (commercial) 500 cycles minimum (to VG 95 234)

Salt Spray Salt-spray resistant platings

Heat +125°C (+257°F) for 1000 hours

Chemical Resistance Tested un-mated and mated according to VG 95 234 for hydraulic fluid, lubricating oil, fuels, humidity, water, salt water, solvents, and corrosion resistance.

Vibration 200 m/s² at 10 to 2,000 Hz. To VG 95 234 Test 5.16

Shock 50g 11ms, three major axes. To VG 95 234 Test 5.17

Contact Type Hard silver crimp

No. of Circuits 1 to 65

Contact Insertion From rear with simple hand tool. Removable, 5 cycles minimum.

Contact Retention Pin and socket contacts are designed to resist severe vibration and repeated connection and disconnection. Contact retention and separation is tested according to VG 95 319 Part 2. Contact retention to test 5.4 with test force in mating direction. Separations force test 5.7 using required test gauge.

CONTACT SIZE	RETENTION FORCE NEWTONS (LBS)		SEPARATION FORCE MIN. NEWTONS (LBS)		GAUGE
16	35"	(7.9)	1"	(0.22)	G 1.56
12	55"	(12.4)	1.5"	(0.34)	G 2.36
8	80"	(18.0)	3"	(0.67)	G 3.58
4	90"	(20.2)	4"	(0.90)	G 5.69
0	95"	(21.4)	8.5"	(1.9)	G 9.04

Heavy-Duty Locking Connectors (HDLC) (Continued)

LAYOUT BY NUMBER OF CONTACTS

View from Mating Face of Pin Insulator: * = Most Popular Layouts

3 CONTACTS



LAYOUT	20-3	20-6	20-19	22-2	22-9	22-21
# OF CONTACTS	3-#12	3-#16	3-#8	3-#8	3-#12	2-#16; 1-#0
SERVICE RATING	D	D	A	D	E	A

4 CONTACTS

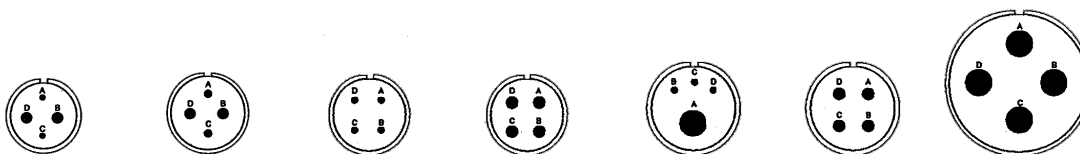

LAYOUT	20-24	22-4	22-10	22-22*	24-4	24-22*	36-5
# OF CONTACTS	2-#16; 2-#8	2-#12; 2-#8	4-#16	4-#8	3-#16; 1-#0	4-#8	4-#0
SERVICE RATING	A	A	E	A	D	D	A

5 CONTACTS



LAYOUT	22-12	24-12
# OF CONTACTS	3-#16; 2-#8	3-#12; 2-#4
SERVICE RATING	D	A

6 CONTACTS



LAYOUT	20-8	20-22
# OF CONTACTS	4-#16; 2-#8	3-#16; 3-#8
SERVICE RATING	I	A

6 CONTACTS (Continued)

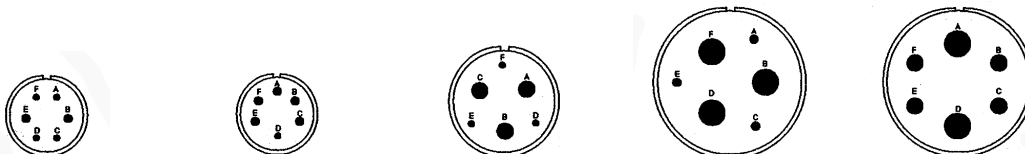

LAYOUT	22-5	22-15	28-22	36-3	36-6
# OF CONTACTS	4-#16; 2-#12	1-#16; 5-#12	3-#16; 3-#4	3-#12; 3-#0	4-#4; 2-#0
SERVICE RATING	D	A(A,B,C,E,F);	D	D	A

Heavy-Duty Locking Connectors (HDLC) (Continued)

LAYOUT BY NUMBER OF CONTACTS (Continued)

View from Mating Face of Pin Insulator: * = Most Popular Layouts

7 CONTACTS

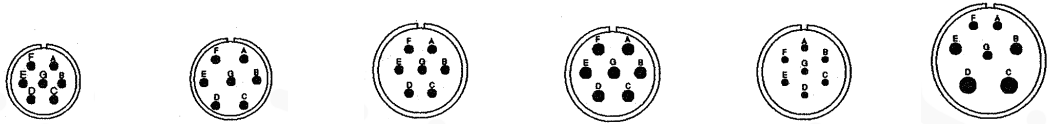

LAYOUT	20-15*	22-28	24-2	24-10	24-27	28-10
# OF CONTACTS	7-#12	7-#12	7-#12	7-#8	7-#16	3-#12; 2-#8; 2-#4
SERVICE RATING	A	A	D	A	E	D(G); A(BALANCE)

8 CONTACTS



LAYOUT	20-7*	22-18	22-23	36A35
# OF CONTACTS	8-#16	8-#16	8-#12	4-#16; 4-#0
SERVICE RATING	A(C-F); D(A,B,G,H)	A(C-E); D(BALANCE)	D(H); A(BALANCE)	A

9 CONTACTS



LAYOUT	20A9	20-16	20-18*	22-16	22-20	22-27
# OF CONTACTS	9-#12	7-#16; 2-#12	6-#16; 3-#12	6-#16; 3-#12	9-#16	8-#16; 1-#8
SERVICE RATING	D(J); ALL OTHERS I	A	A	A	A	D(J); A(BALANCE)

9 CONTACTS (Continued)



LAYOUT	24-11*	28A16
# OF CONTACTS	6-#12; 3-#8	5-#16; 4-#4
SERVICE RATING	A	A

10 CONTACTS

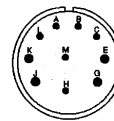

LAYOUT	28-19
# OF CONTACTS	6-#16; 4-#12
SERVICE RATING	A(C,E,G,J,K,L); B(H,M); D(A,B)

11 CONTACTS

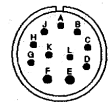

LAYOUT	24-20
# OF CONTACTS	9-#16; 2-#12
SERVICE RATING	D

Mini Quick-Connects™
 Micro Quick-Connects™
 Nano Quick-Connects™
 Specialty Quick-Connects™
 Ethernet Cable Assemblies
 7 Pin Molded Valve Plug
 DIN Connectors
 Extension Cords
 M23 Connector Assemblies
 Military Connectors
 Rectangular Connectors

Heavy-Duty Locking Connectors (HDLC) (Continued)

LAYOUT BY NUMBER OF CONTACTS

View from Mating Face of Pin Insulator: * = Most Popular Layouts

12 CONTACTS

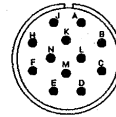
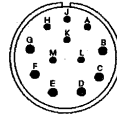
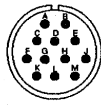
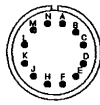

13 CONTACTS



LAYOUT	24-19	24A24	28-51	28-51	22-21
# OF CONTACTS	12-#16	12-#12	6-#16; 6-#12	3-#8	2-#16; 1-#0
SERVICE RATING	A	A	D	D	A

14 CONTACTS

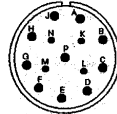
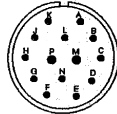
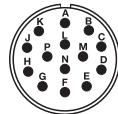

16 CONTACTS

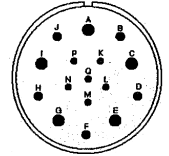
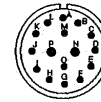
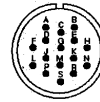

LAYOUT	20-27*	22-19*	28-2	28-20	24-5	24-7*	36-14
# OF CONTACTS	14-#16	14-#16	12-#16; 2-#12	4-#16; 10-#12	16-#16	14-#16; 2-#12	6-#16; 5-#12; 5-#8
SERVICE RATING	A	A	D	A	A	A	D

17 CONTACTS



19 CONTACTS

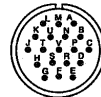

20 CONTACTS

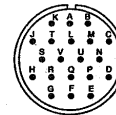

22 CONTACTS

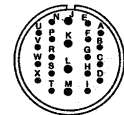

LAYOUT	20-29*	20A48	22-14*	28-16	28-11*
# OF CONTACTS	17-#16	19-#16	19-#16	20-#16	18-#16; 4-#12
SERVICE RATING	A	I	A	A	A

Mini Quick-Connects™
Micro Quick-Connects™
Nano Quick-Connects™
Specialty Quick-Connects™
Ethernet Cable Assemblies
7 Pin Molded Valve Plug
DIN Connectors
Extension Cords
M23 Connector Assemblies
Military Connectors
Rectangular Connectors

Heavy-Duty Locking Connectors (HDLC) (Continued)

LAYOUT BY NUMBER OF CONTACTS (Continued)

View from Mating Face of Pin Insulator: * = Most Popular Layouts

24 CONTACTS

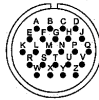

LAYOUT	24-28*
# OF CONTACTS	16/24
SERVICE RATING	I

26 CONTACTS

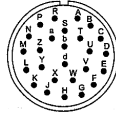

LAYOUT	28-12*
# OF CONTACTS	26-#16
SERVICE RATING	A

27 CONTACTS

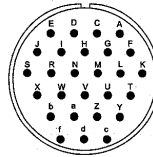

LAYOUT	36A46
# OF CONTACTS	27-#12
SERVICE RATING	A

28 CONTACTS

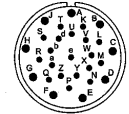
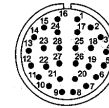

LAYOUT	24A28	28A63
# OF CONTACTS	28-#16	9-#12; 19-#16
SERVICE RATING	I	A

31 CONTACTS

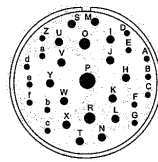

LAYOUT	36-9
# OF CONTACTS	14-#16; 14-#12; 2-#8; 1-#4
SERVICE RATING	A

35 CONTACTS

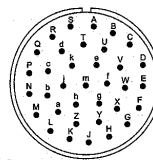
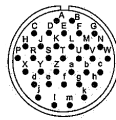

LAYOUT	28-15*	36-15
# OF CONTACTS	35-#16	35-#16
SERVICE RATING	A	D(M); A(BALANCE)

37 CONTACTS

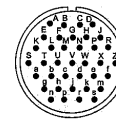

LAYOUT	28-21*
# OF CONTACTS	37-#16
SERVICE RATING	A

39 CONTACTS

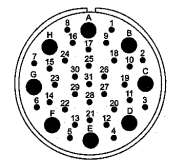

LAYOUT	36A98
# OF CONTACTS	8-#8; 31-#16
SERVICE RATING	A

43 CONTACTS

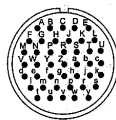

LAYOUT	28A51
# OF CONTACTS	43-#16
SERVICE RATING	A

47 CONTACTS

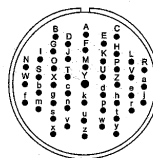
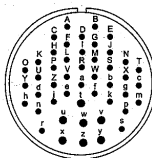

LAYOUT	36-7*	36-8
# OF CONTACTS	40-#16; 7-#12	46-#16; 1-#12
SERVICE RATING	A	A

48 CONTACTS

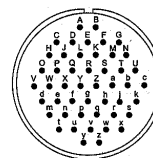

LAYOUT	36-10*
# OF CONTACTS	48-#16
SERVICE RATING	A

Heavy-Duty Locking Connectors (HDLC) (Continued)

DIMENSIONS

PANEL MOUNT RECEPTACLE

Panel mount receptacles are for wall or panel mounting and are supplied with crimp contacts, individual wire sealing grommet, ferrule, end bell, gasket, nut plate and screws.

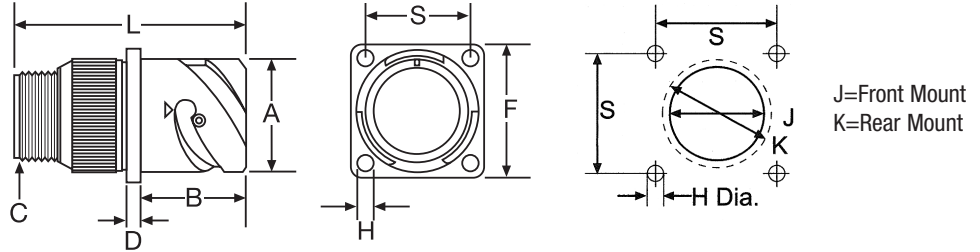

SIZE	A DIA. (IN)	B (IN)	C THREAD	D (IN)	L MAX. (IN)	F (IN)	S (IN)	H (IN)	J (IN)	K (IN)
20	1.350	0.910	1-3/16-18UNEF-2A	0.160	2.480	1.500	1.160	0.130	1.160	1.360
22	1.470	0.910	1-3/16-18UNEF-2A	0.160	2.600	1.650	1.250	0.130	1.290	1.490
24	1.610	0.910	1-7/16-18UNEF-2A	0.160	2.720	1.750	1.370	0.150	1.420	1.630
28	1.840	0.950	1-7/16-18UNEF-2A	0.160	2.760	2.000	1.560	0.150	1.650	1.850
32	2.100	0.950	1-3/4-18UNS-2A	0.160	2.790	2.240	1.750	0.170	1.900	2.120
36	2.350	0.950	2-18UNS-2A	0.160	2.870	2.500	1.940	0.170	2.150	2.360

SHELL SIZE	CABLE RANGE
20	0.188" – 0.875"
22	0.188" – 0.875"
24	0.688" – 0.875"

SHELL SIZE	CABLE RANGE
28	0.562" – 1.125"
32	0.750" – 1.125"
36	0.875" – 1.688"

PART NUMBER	DESCRIPTION
1X	Straight Male Panel Mount Receptacle
2X	Straight Female Panel Mount Receptacle

CABLE CONNECTING RECEPTACLE

Cable connecting receptacles are for in-line cable connection and are supplied with crimp contacts, individual wire sealing grommet, ferrule, deluxe strain relief backshell, gasket, nut plate and screws.

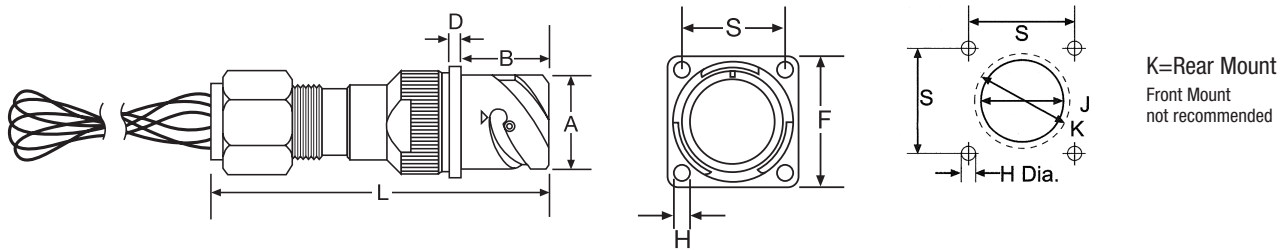

SHELL SIZE	A DIA. (IN)	B (IN)	D (IN)	L REF. (IN)	F (IN)	S (IN)	H (IN)	K (IN)
20	1.346	0.907	0.157	5.400	1.496	1.157	0.126	1.358
22	1.472	0.907	0.157	5.830	1.654	1.252	0.126	1.488
24	1.610	0.907	0.157	6.030	1.752	1.374	0.146	1.626
28	1.839	0.947	0.157	6.050	2.000	1.563	0.146	1.854
32	2.102	0.947	0.157	6.280	2.244	1.752	0.169	2.118
36	2.346	0.947	0.157	6.560	2.500	1.937	0.169	2.362

SHELL SIZE	CABLE RANGE
20	0.188" – 0.875"
22	0.188" – 0.875"
24	0.688" – 0.875"

SHELL SIZE	CABLE RANGE
28	0.562" – 1.125"
32	0.750" – 1.125"
36	0.875" – 1.688"

PART NUMBER	DESCRIPTION
5X	Straight In-line Male Receptacle
6X	Straight In-line Female Receptacle

Mini Quick-Connects™
 Micro Quick-Connects™
 Nano Quick-Connects™
 Specialty Quick-Connects™
 Ethernet Cable Assemblies
 7 Pin Molded Valve Plug
 DIN Connectors
 Extension Cords
 M23 Connector Assemblies
 Military Connectors
 Rectangular Connectors